



4MP WDR Optical Zoom Bullet IP Camera



User's Manual

DN-16084-1

Ver. 1.0

Table of Contents

1. Overview	2
1.1 Features	2
1.2 Package Contents	3
1.3 Dimensions	4
1.4 microSD Card Slot / Factory Default Button	5
2. Camera Cabling	6
2.1 All-in-One Cable	6
2.2 Connect Power	7
2.3 Connect Ethernet Cable	7
2.4 Connect Alarm I/O	7
2.5 Waterproof Cable Connectors	8
3. Installation	9
3.1 Ceiling / Wall Mounting	9
4. System Requirements	11
5. Access Camera	12
6. Setup Video Resolution	15
7. Configuration Files Export / Import	16
8. Tech Support Information	17
8.1 Delete the Existing Viewer	17
8.2 Setup Internet Security	18
Appendix: Technical Specifications	

1. Overview







DN-16084-1 equipped with an outstanding processing engine delivers 4K real-time streaming that provides 4 times details of Full HD resolution without sacrificing the frame rate. Software features, such as Privacy masks and ROI windows, further extend the range of camera application. The new generation built-in IR LED module emits sufficient infrared lights to light up the area under surveillance without the help of any additional lighting devices. The cable management bracket not only saves the time on installation but also keeps the cables from sabotage. With the international IP66 rating and weather-proof design, the Bullet IP camera can also perform stably in harsh environments.

1.1 Features

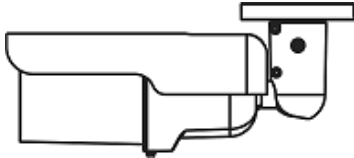
- 4MP Progressive Scan CMOS Sensor
- Quad Streams Compression- H.264 Baseline / Main / High Profile + MJPEG
- Multiple and Dynamic ROI Windows
- 3D Motion Compensated Noise Reduction (MCTF)
- Text Overlay and Privacy Masks
- Smart Event Function-
Motion Detection / Network Failure Detection / Tampering Alarm / Periodical Event / Manual Trigger / Audio Detection
- Remote Zoom & Focus (Motorized Lens)
- Smart IR Mode
- Day/Night (ICR)
- IR LED Module (working distance up to 50 m)
- micro SD Support
- Weatherproof (IP66 International)
- Integrated Mounting Bracket with Cable Management
- ONVIF Support

1.2 Package Contents

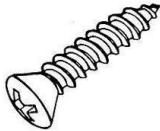
Please check the package contains the following items listed below.

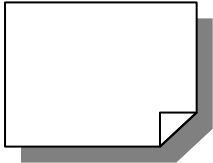
 Hyper IR Bullet IP Camera (Cable included)	
 Power Terminal Block (x1)	 Alarm Terminal Block (x1)
 Plastic Screw Anchor (x5)	 M4 Self-Tapping Screw (x5)
 CD (bundled software and documentation)	 Quick Guide

1.3 Dimensions

The dimensions of the camera are shown below.

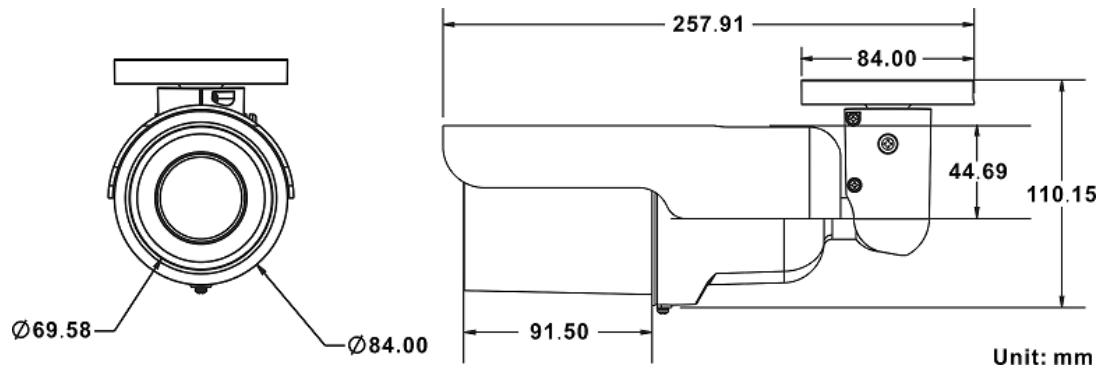

1.4 microSD Card Slot / Factory Default Button

The camera's microSD card slot and factory default button are inside the front housing. If users need to use them, the front housing must be opened. Follow the steps below to reach microSD card slot and factory default button.

Step 1:

Loosen the screw on the camera housing but do not detach it. Then separate the front housing from the camera.

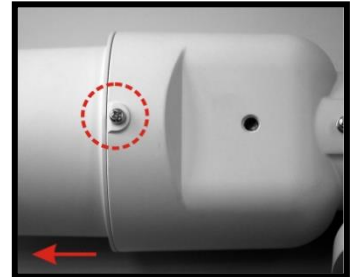

Step 2:

The positions of microSD card slot and default button are as shown below.

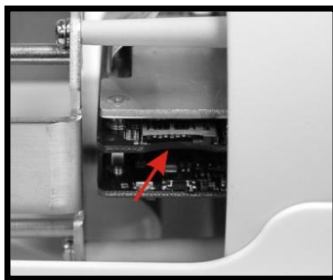

microSD Card Slot

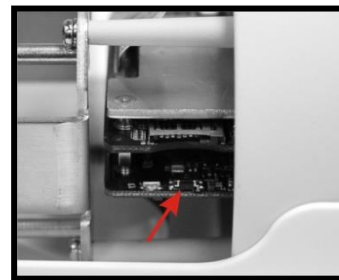

Default Button



NOTE: It is not recommend to record with the microSD card for 24/7 continuously, as it may not be able to support long term continuous data read/write. Please contact the manufacturer of the microSD card for information regarding the reliability and life expectancy.

Step 3:

Install the front housing to the camera, and tighten the screw on the camera housing.

2. Camera Cabling

Before users connect cables, make sure that all cables and the power adaptor are placed in dry and well-waterproofed environments, e.g. waterproof boxes. The purpose is to prevent moisture accumulation inside the camera and moisture penetration into cables, which might lead to camera breakdown. Please refer to the following sections to complete camera connection.

2.1 All-in-One Cable

The diagram below shows the All-in-One cable of the camera. Definition for each cable is also given as follows.

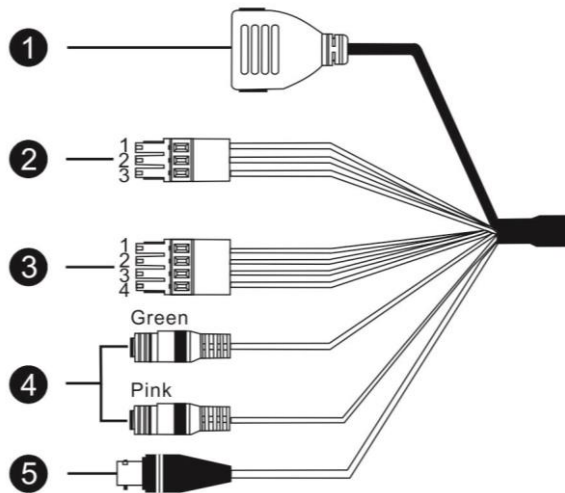

No	Cable	Pin	Definition	Remarks
1	RJ-45	-	For network and PoE connections	
2	Power (DC 12V / AC 24V) (3-pin Terminal Block)	1	DC 12V - AC 24V 1	Power connection
		2	Reserved GND	
		3	DC 12V + AC 24V 2	
3	Alarm I/O (4-pin Terminal Block)	1	Alarm In -	Alarm connection
		2	Alarm In +	
		3	Alarm Out -	
		4	Alarm Out +	
4	Audio I/O	Green	Audio Out	Two-way audio transmission
		Pink	Audio In / Mic In	
5	BNC	-	For analog video output	

2.2 Connect Power

For power connection, please use an AC 24V / DC 12V adaptor and connect it to the 3-pin terminal block of the All-in-One cable and the power outlet. Alternatively, users can power the camera by PoE if a Power Sourcing Equipment (PSE) switch is available. Please refer to the section below for Ethernet cable connection.



NOTE: If PoE is used, make sure PSE is in used in the network.

2.3 Connect Ethernet Cable

To have the best transmission quality, cable length shall not exceed 100 meters. Connect one end of the Ethernet cable to the RJ-45 connector of the All-in-One cable, and plug the other end of the cable to the network switch or PC.



NOTE: In some cases, Ethernet crossover cable might be needed when connecting the camera directly to the PC.

Check the status of the link indicator and the activity indicator LEDs. If the LEDs are unlit, please check the LAN connection.

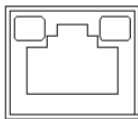

Green Link Light indicates good network connection.

Orange Activity Light flashes for network activity indication.

2.4 Connect Alarm I/O

For alarm I/O connection, please connect alarm devices to the 4-pin terminal block of the All-in-One cable.

2.5 Waterproof Cable Connectors

Follow the steps below to waterproof the connectors of the All-in-One cable.

Step 1:

Connect the required devices to the All-in-One cable and coat the joints with silicone gel. There should be no gap between the connectors and the cables. For alarm I/O connector and power connector, make sure the side with wires attached is also sealed with silicone gel.

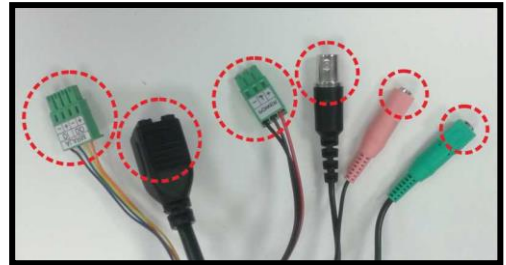

Step 2:

Seal the end of the rubber coating of the All-in-One cable as indicated in the figure on the right. Please use enough silicone gel to fill in the hose and wrap around each wires; otherwise, waterproof function cannot be guaranteed.

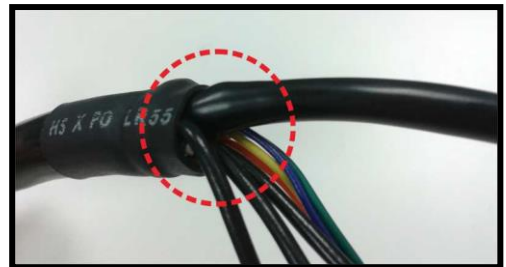

3. Installation

Please read the instructions provided in this chapter thoroughly before installing the camera.

3.1 Ceiling / Wall Mounting

The camera can be installed directly on a wall or ceiling with the integrated 2-axis adjustable Bracket Mount. Please note that the wall or ceiling must have enough strength to support the camera.

Follow the steps below to install the camera.

Step 1:

Place the camera at the installation location. On the ceiling / wall, mark the position of the two screw holes of the camera.

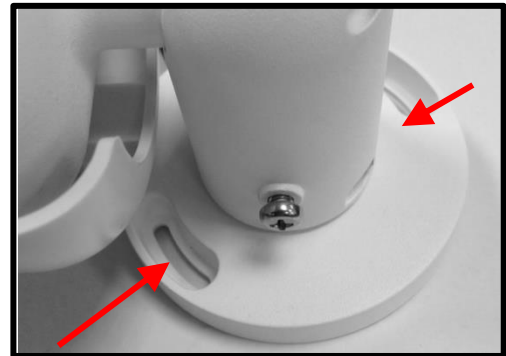

If the screw holes are blocked by the camera body, loosen the three screws shown in the right figures but do not detach it. Then rotate the camera body to reach the screw holes.

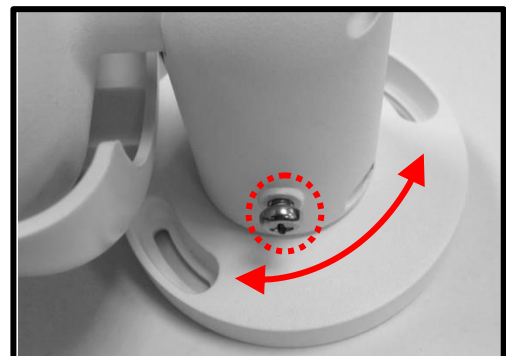
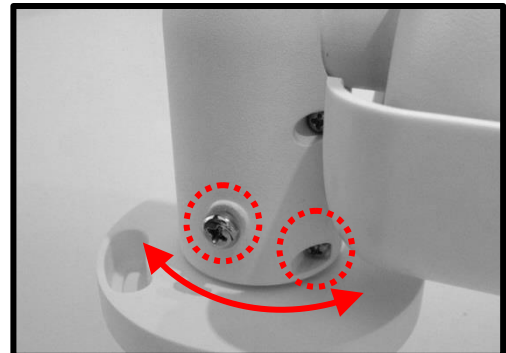

Step 2:

At the center of the three marked holes, draw a cable entry hole with 30 mm diameter (radius as 15 mm) and drill the cable entry hole. Then drill a hole slightly smaller than the supplied plastic screw anchor on each marked screw hole. Lastly, insert the plastic screw anchors into the drilled holes.

Step 3:

Thread the All-in-One cable of the camera through the cable entry hole. Refer to chapter Camera Cabling for cable connections.

Step 4:

Match the two screw holes of the camera with the plastic screw anchors at the installation location. Fasten the camera with the supplied M4x31 self-tapping screws.

Step 5:

Use a cross screwdriver to loosen the four screws indicated in the right figures. Do not detach the screws. Rotate the camera and point the camera to a desired direction. Lastly, tighten the four screws to secure the camera.

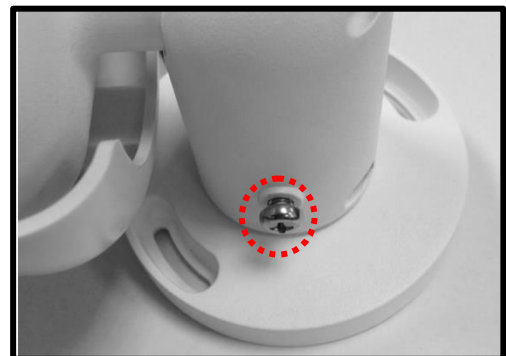
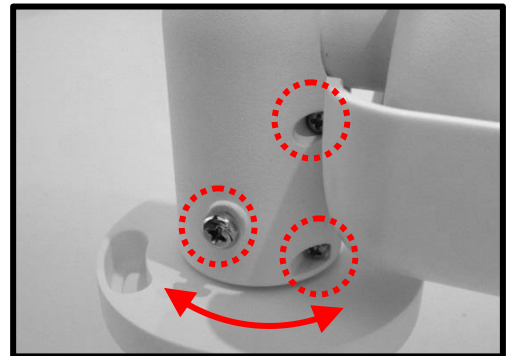

4. System Requirements

To perform the camera via web browser, please ensure the PC is in good network connection, and meet system requirements as described below.

Items	System Requirement
Personal Computer	Minimum : 1. Intel® Core™ i5-2430M @ 2.4 GHz 2. 2 GB RAM or more
	Recommended : 3. Intel® Core™ i7-870 @ 2.93 GHz 4. 8 GB RAM
Operating System	Windows VISTA / Windows XP / Windows 7
Web Browser	Microsoft Internet Explorer 6.0 or later Firefox Chrome Safari
Network Card	10Base-T (10 Mbps) or 100Base-TX (100 Mbps) or 1000Base-T operation
Viewer	ActiveX control plug-in for Microsoft IE

5. Access Camera

For initial access to the IP camera, users can search the camera through the installer program: DeviceSearch.exe, which can be found in “DeviceSearch” folder in the supplied CD.

Accessing the Camera by Device Search Software

- Step 1:** Double click on the program Device Search.exe.
- Step 2:** After its window appears, click on the <Device Search> button on the top. All the finding IP devices will be listed in the page.
- Step 3:** Find the camera in the list by its IP address and click on it. The default IP address of the camera is: **192.168.0.250**.
- Step 4:** The default IP address of the camera may not be in the same LAN as the IP address of the PC. If so, the IP address of the camera needs to be changed. Right click on the camera and click <Network Setup>. Meanwhile, record the MAC address of the camera, for future identification.
- Step 5:** The <Network Setup> page will come out. Select <DHCP> and click <Apply> down the page. The camera will be assigned with a new IP address.
- Step 6:** Click <OK> on the Note of setting change. Wait for one minute to re-search the camera.
- Step 7:** Click on the <Device Search> button to re-search all the devices. Find the camera in the list by its MAC address. Then double click or right click and select <Browse> to access the camera directly via a web browser.

Step 8: A prompt window requesting for default username and password will appear. Enter the default username and password shown below to login to the camera.

Login ID	Password
admin	admin



NOTE: ID and password are case sensitive.



NOTE: It is strongly advised that administrator's password be altered for the security concerns. Refer to the [Camera's Web UI Manual](#) in the supplied CD for further details.

Installing Viewer Software Online

For the initial access to the camera, a client program, Viewer, will be automatically installed to the PC when connecting to the camera.

If the web browser doesn't allow Viewer installation, please check the Internet security settings or ActiveX controls and plug-ins settings (refer to section [Setup Internet Security](#)) to continue the process.

The Information Bar (just below the URL bar) may come out and ask for permission to install the ActiveX Control for displaying video in browser. Right click on the Information Bar and select <Install ActiveX Control...> to allow the installation.

The download procedure of Viewer software is specified as follows.

Step 1: In the Viewer installation window, click on <Next> to start installation.

Step 2: The status bar will show the installation progress. After the installation is completed, click on <Finish> to exit the installation process.

Step 3: Click on <Finish> to close the Viewer installation page.

Once the Viewer is successfully installed, the Home page of the IP camera will be displayed as the figure below.

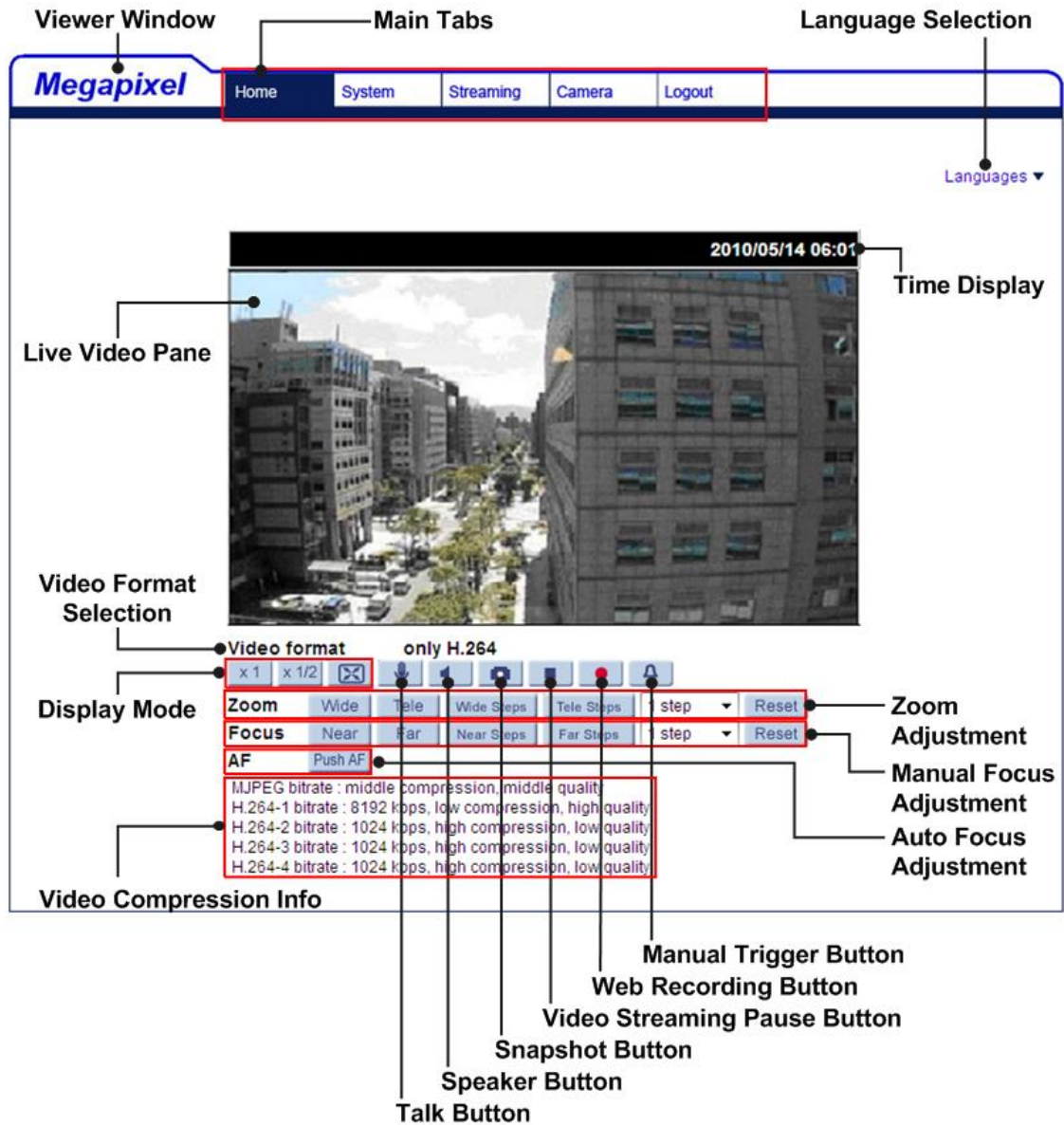

Zoom and Focus Adjustment

The live image will be displayed on the Home page when the camera is successfully accessed. If zoom or focus is not at the desired position, please use the function buttons on the Home page to adjust zoom and focus.



NOTE: Please refer to the Camera's Web UI Manual in the supplied CD for more button function details.

6. Setup Video Resolution

Users can setup video resolution on Video Format page of the user-friendly browser-based configuration interface.

Video Format can be found under this path: **Streaming> Video Format**.

Megapixel Home System **Streaming** Camera Logout

Video Format

Video Format

Video Resolution :

H.264 + H.264 + H.264 + H.264

H.264-1 format : 1920 x 1080 (15 fps)

H.264-2 format : 1280 x 1024 (15 fps)

H.264-3 format : 1280 x 720 (15 fps)

H.264-4 format : 720 x 480 (15 fps)

Save

Note :
Image attachment by FTP or E-mail will be available only while MJPEG streaming is selected.

Text Overlay Settings :

Include date Include time

Include text string:

Save

Video Rotate Type :

Normal video

Save

GOV Settings :

H.264-1 GOV Length : H.264-2 GOV Length :

H.264-3 GOV Length : H.264-4 GOV Length :

Save

H.264 Profile :

H.264-1 : H.264-2 :

H.264-3 : H.264-4 :

Save

The default values of video resolution are as below.

4M	Real-Time	H.264- 4M (30/25 fps) + H.264- D1 (30/25 fps)
-----------	------------------	---

For more details about the combinations of video resolution, please refer to the Camera's Web UI Manual in the supplied CD.

7. Configuration Files Export / Import

To export / import configuration files, users can access the Maintenance page on the user-friendly browser-based configuration interface.

The Maintenance setting can be found under this path: **System> Maintenance**.

Users can export configuration files to a specified location and retrieve data by uploading an existing configuration file to the camera. It is especially convenient to make multiple cameras having the same configuration.

Export

Users can save the system settings by exporting the configuration file (.bin) to a specified location for future use. Click on the <Export> button, and the popup File Download window will come out. Click on <Save> and specify a desired location for saving the configuration file.

Upload

To upload an existing configuration file to the camera, please first click on <Browse> to select the configuration file, and then click on the <Upload> button for uploading.

8. Tech Support Information

This chapter will introduce how to delete previously-installed Viewer in the PC and how to setup the Internet security.

8.1 Delete the Existing Viewer

For users who have installed the Viewer in the PC previously, please first remove the existing Viewer from the PC before accessing to the IP camera.

Deleting the Viewer

In the Windows <Start Menu>, activate <Control Panel>, and then double click on <Add or Remove Programs>. In the <Currently installed programs> list, select <Viewer> and click on the button <Remove> to uninstall the existing Viewer.

Deleting Temporary Internet Files

To improve browser performance, it is suggested to clean up all the files in the <Temporary Internet Files>. The procedure is as follows.

Step 1: Click on the <Tools> tab on the menu bar and select <Internet Options>.

Step 2: Click on the <Delete> button under <Browsing history> section.

Step 3: In the appeared window, tick the box beside <Temporary Internet files> and click on < Delete> to start deleting the files.

8.2 Setup Internet Security

If ActiveX control installation is blocked, please either set Internet security level to default or change ActiveX controls and plug-ins settings.

Internet Security Level: Default

Step 1: Start the Internet Explorer (IE).

Step 2: Click on the <Tools> tab on the menu bar and select <Internet Options>.

Step 3: Click on the <Security> tab, and select <Internet> zone.

Step 4: Down the page, click on the <Default Level> button and click on <OK> to confirm the setting. Close the browser window, and restart a new one later to access the IP camera.

ActiveX Controls and Plug-ins Settings

Step 1: Repeat **Step 1 to Step 3** of the previous section above.

Step 2: Down the page, click on the <Custom Level> button to change ActiveX controls and plug-ins settings. The Security Settings window will pop up.

Step 3: Under <ActiveX controls and plug-ins>, set **ALL** items (as listed below) to <Enable> or <Prompt>. Please note that the items vary by IE version.

ActiveX controls and plug-ins settings:

1. Binary and script behaviors.
2. Download signed ActiveX controls.
3. Download unsigned ActiveX controls.
4. Allow previously unused ActiveX controls to run without prompt.
5. Allow Scriptlets.
6. Automatic prompting for ActiveX controls.
7. Initialize and script ActiveX controls not marked as safe for scripting.
8. Run ActiveX controls and plug-ins.
9. Only allow approved domains to use ActiveX without prompt.
10. Script ActiveX controls marked safe for scripting*.
11. Display video and animation on a webpage that does not use external media player.

Step 4: Click on <OK> to accept the settings. A prompt window will appear for confirming the setting changes, click <Yes(Y)> to close the Security Setting window.

Step 5: Click on <OK> to close the Internet Options screen.

Step 6: Close the browser window, and restart a new one later to access the IP camera.